

## SÖ-35 ÖZEL CONTA

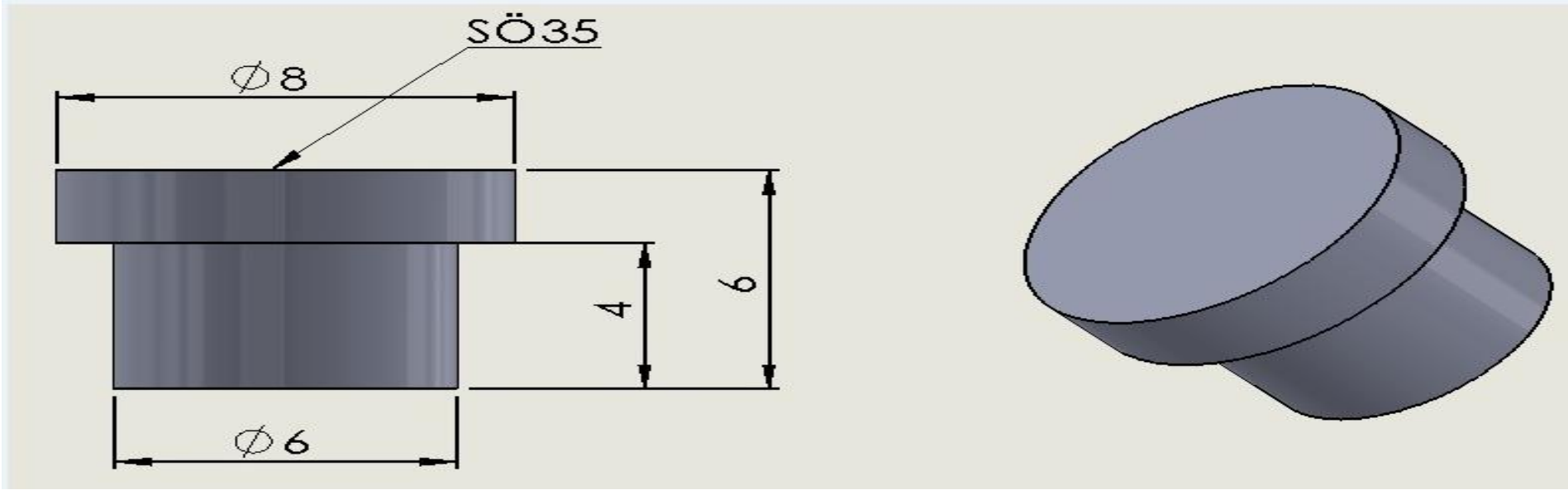

KOD	$\phi d$	$\phi D$	H	BİRİM FİYAT
SCÖ-35	6	8	6	FS