

## SÖ-58 ÖZEL CONTA

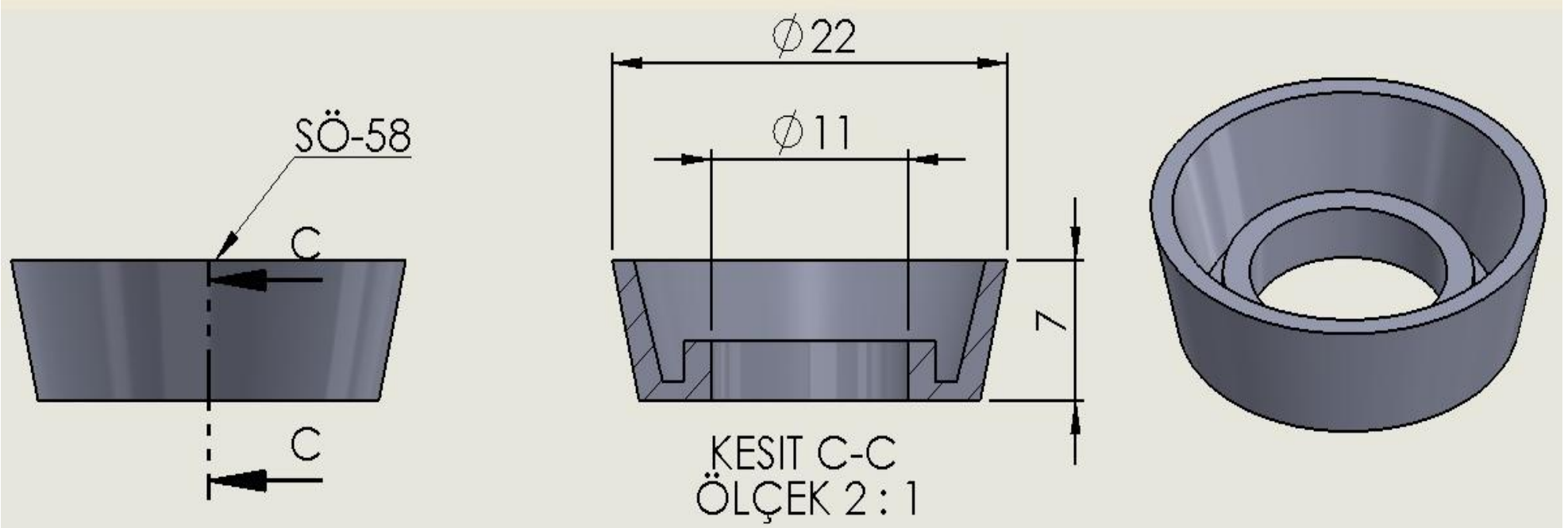

KOD	$\varnothing d$	$\varnothing D$	H	BİRİM FİYAT
SCÖ-58	11	22	7	FS

